

Notes:

1 Square = ____ Foot/Feet

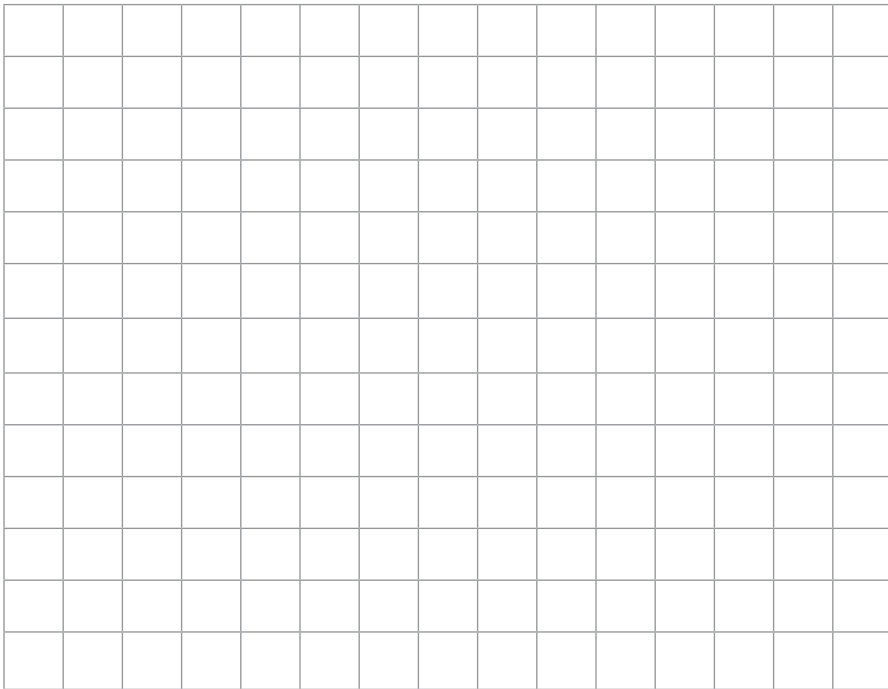

National Garden Wholesale.
VANCOUVER, WASHINGTON U.S.A. 

www.titancontrols.net

Revision H – 12/31/2014 © Titan Controls®



TITAN[®]
CONTROLS

ATLAS[®] 2

Preset CO₂ Monitor/Controller
Instruction Manual



Sunlight Supply, Inc.

National Garden Wholesale.

VANCOUVER, WASHINGTON U.S.A.



www.titancontrols.net

Atlas® 2

- Warnings
- Atlas® 2–Preset CO₂ Monitor/Controller Overview
- Instructions for Operation
- Calibration Mode
- Error Mode
- Controller Specifications
- Installation Examples
- Warranty Information
- Service and Repair Program

Warnings:

- Read all instructions before operating controller.
- Do not put your controller in an area where it can get wet or sprayed.
- Mount your controller securely to the wall using hardware provided.
- When using “bug bombs” in area, cover controller completely to avoid corrosion.
- Do not put paperclips, tools, etc. into unit. Possible electrocution may occur.
- Make sure to verify the voltage, amperage and hertz of the power source prior to plugging in and activating the controller.
- Check that all devices that will be activated by this controller are the proper voltage.
- This controller is designed for ‘Inside Use’ only.
- Avoid placing the controller near heat generating sources.
- Use caution when operating controller in extremely humid environments.
- Do not use controller for purposes other than the unit was designed to function.
- Use controller within defined environmental specifications.
- Ask your Dealer for tips and techniques regarding the use of this controller.
- Be conscientious when disposing of any products.
- Enjoy your Titan Controls® CO₂ controller for years to come!

Atlas® 2 Preset CO₂ Monitor/Controller Overview:

The Titan Controls® Atlas® 2 CO₂ preset CO₂ controller monitors, maintains and displays the CO₂ concentration in your growing environment. The CO₂ readings are displayed by four green LED’s, with each LED indicating a minimum CO₂ concentration. The Atlas® 2 is equipped with a photocell, LED display and a one button calibration that calibrates the Atlas® 2 to the approximate concentration of outside air.

WARRANTY SERVICE: Please read warranty information first.

If after reviewing the troubleshooting tips the unit will still not work, you should return it to the Dealer where you purchased the controller. They will be able to further evaluate the unit and test its various components and quite possibly will be able to identify and/or fix any problems. If the Dealer is unable to fix the unit, they will return it to us for factory repair.

If there are no Dealers in your area, you may contact us directly for technical support. If we cannot help you resolve the problem over the phone, we will issue you a RMA # (return merchandise authorization) authorizing you to return the unit to us for factory reconditioning (if the unit is under warranty). Contact the number below for a RMA and shipping address. Complete the form below and include it with your unit. Also please write the RMA # on the outside of the box.

Please package the unit in its original packaging. If it is damaged in shipment we cannot be responsible.

Once we receive the unit back, we will repair the controller within 48 hours (business) and return it to you freight prepaid via UPS ground shipment.

Include the following if returning directly to Titan Controls®

- Proof of purchase • This completed form • RMA # on the outside of the box

Return Merchandise Authorization Number (Required)

Company Name: _____

Contact Name: _____

Address: _____

Phone #: _____

Email address: _____

What is the nature of the problem? _____

Send to your nearest location – shipping address will be given when the RMA # is issued.



www.titancontrols.net

For technical assistance call us at 1-888-80-Titan or 1-888-808-4826.
Representative available Monday – Friday, 8 a.m. – 5 p.m. PST.

Warranty Information:

- Titan Controls® warrants the original purchase of this product against defects in material and workmanship under normal use for three (3) years from the date of purchase.
- During the warranty period, Titan Controls® will, at our option, and without charge, repair or replace this product if the controller or any of its components fail or malfunction.
- All returns or repairs must be accompanied by a Return Merchandise Authorization (RMA) number prior to any service of the product.
- This warranty is expressly in lieu of all other warranties, expressed or implied, including the warranties of merchantability and fitness for use and of all other obligations or liabilities on the part of the seller.
- This warranty shall not apply to this product or any part thereof which had been damaged by accident, abuse, misuse, modification, negligence, alteration or misapplication.
- Controllers with serial numbers or date tags that have been removed, altered or obliterated; broken seals or that show evidence of tampering; mismatched board serial numbers or nonconforming parts; are excluded from coverage.
- Titan Controls® makes no warranty whatsoever in respect to accessories or parts not supplied by Titan Controls®.
- Monetary refunds of the warranty will not be given.
- The Buyer assumes all responsibility regarding the use & installation of this controller.
- All warranty service is provided through the factory or an authorized service representative.
- This warranty shall apply only to the United States, including Alaska, Hawaii and territories of the United States.
- Defective controllers need to be returned with the “proof of purchase” receipt.
- For additional warranty information, contact a Titan Controls® Technical Service Representative or your Dealer. Service Representative available for help **Monday - Friday, 8 a.m. to 5 p.m. PST. We are closed most major holidays. Call toll free: 1-888-808-4826.**
- NOTE: Titan Controls® is a controller manufacturer. All sales offerings to the public are done through a nationwide group of Dealers. No sales offerings will be made directly to the general public.

Service and Repair Program:

- For all service and repairs please contact our Technical Service Representative for a Return Merchandise Authorization (RMA) number.
- All factory service & repairs will be completed within 48 hours of receipt of controller and after authorization by customer for repairs.
- Titan Controls® will, at its discretion, repair or replace the controller.
- Factory calibration services are available for all Titan Controls®.
- Returning Units: Please contact your retail store for returns.

Instructions for Operation:

The Atlas® 2 is equipped with a photocell that changes how the controller operates depending on the light in the room.

Day time:

The Atlas® 2 has a preset CO₂ set point of 1500 PPM (Parts per Million) with a 100 PPM dead band. When the CO₂ concentration in your room drops below 1400 PPM the ‘load’ output will be enabled, activating the 120 VAC output. When the CO₂ concentration rises above 1500 PPM the ‘load’ output will be disabled.

Night time:

The ‘load’ output of the Atlas® 2 is disabled in the night time period (when your grow room is dark); however the controller will continue to monitor and display your grow rooms CO₂ level.

How the Atlas® 2 works!

The Atlas® 2 has four (4) green LED’s that are used to display the CO₂ concentration in your grow room. An illuminated LED shows that the concentration is at least the PPM noted under the LED. As the CO₂ rises in your grow room, the LED’s showing the indicated concentration will remain illuminated.

If the Atlas® 2 has the ‘load’ output ‘ON’, the illuminated LED’s will quickly flash twice approximately every three seconds. If the controllers load output is ‘OFF’, the illuminated LED’s will remain solid on.

Display CO₂ below 1000 PPM:

If the CO₂ concentration is below 1000 PPM (Figure 1) all LED’s will be off; however the 1000 PPM LED will flash one (1) time approximately every three (3) seconds to indicate that the sensor is functioning properly. If the load output is ‘ON’, the 1000 PPM LED will flash two (2) times approximately every three (3) seconds.

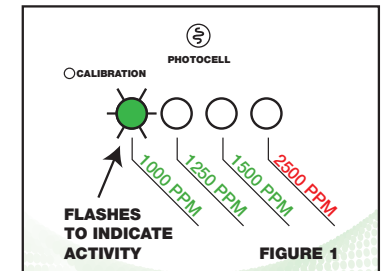

Display CO₂ between 1000 PPM and 1249 PPM:

Figure 2 shows how the CO₂ will be displayed if the CO₂ concentration is above 1000 PPM but below 1250 PPM. If the load output is ‘ON’, this LED will quickly flash two (2) times approximately every three (3) seconds.

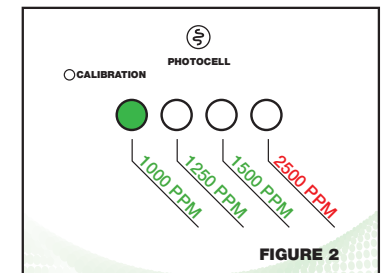

Display CO₂ between 1250 PPM and 1499 PPM:

Figure 3 shows how the CO₂ will be displayed if the CO₂ concentration is above 1250 PPM but below 1500 PPM. If the load output is ‘ON’, these LED’s will quickly flash two (2) times approximately every three (3) seconds.

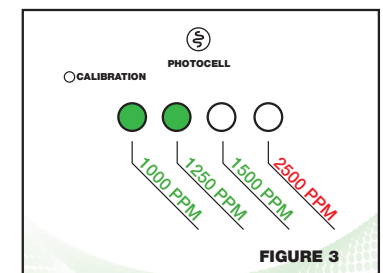

Display CO₂ between 1500 PPM and 2499 PPM

Figure 4 shows how the CO₂ will be displayed if the CO₂ is above 1500 PPM but below 2500 PPM. The LED's will be illuminated but will remain solid.

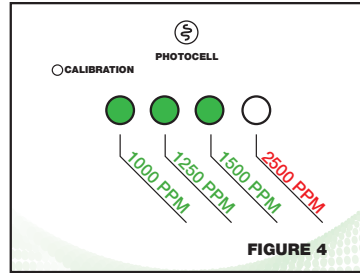

Display CO₂ above 2500 PPM

Figure 5 shows how the CO₂ will be displayed if the CO₂ is above 2500 PPM. Note: the 2500 PPM LED is a different shade of green to indicate a higher concentration of CO₂ than normal. If this LED is illuminated, you may want to take a break from working in your room and seek fresh air.

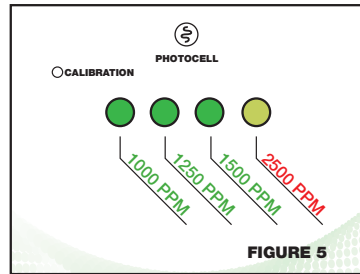

Calibration Mode:

The Atlas® 2 is 'FACTORY CALIBRATED' and does not require calibration out of the box. Occasionally, it needs periodic calibration due to 'drift' in the sensor. This should occur every three (3) years or so. The Atlas® 2 has a single button that is used to place the controller into calibration mode. It will automatically calibrate itself to the outside air. To properly calibrate the Atlas® 2, follow these simple steps:

Step # 1: Take the Atlas® 2 to an outside area where CO₂ pollution is at a minimum (avoid areas where animals, machinery, autos, etc. are located). Try not to breath directly on the Atlas® 2, it will confuse the calibration process.

Step #2: Power up the Atlas® 2.

Step #3: Allow the Atlas® 2 a minimum of five (5) minutes to stabilize in the outside area. For best accuracy, be sure to avoid breathing directly on the controller during this time and while it's calibrating.

Step # 4: Press and hold the "CALIBRATION" button (Figure 6) for approximately three (3) seconds using a toothpick or matchstick. (Use a non-metallic item to avoid potential shock.) Once the LED's begin to cycle back and forth, release the button and allow the unit to complete the calibration process. The calibration process should take less than two (2) minutes.

After completion of the calibration process, the Atlas® 2 will return to normal operation and the LED's will display the current CO₂ PPM concentration of the ambient air.

NOTE: Calibrating to outside air provides a good approximate calibration. The accuracy of the CO₂ calibration will be dependent on the quality of the air that the Atlas® 2 sensor has been exposed to during the calibration process.

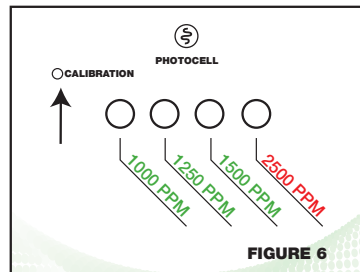

Error Mode:

The Atlas® 2 will go into an ERROR MODE if the following conditions occur:

- The Atlas® 2 is unable to get readings from the CO₂ sensor module.
- The Atlas® 2 is unable to complete the calibration process properly.

While in the ERROR MODE, the Atlas® 2 will disable the 'load' output and flash LED's on, then off, then on, then off, etc.

To RESET your Atlas® 2, simply unplug from power source, count to 10 and then plug back into power source. This normally corrects the problem.

Controller Specifications:

- Size = 8"H x 4.5"W x 2.5"D
- Weight = 1 lbs.
- Input Amperage = 15 Amps
- Output Amperage = 12 Amps
- Voltage Input = 120 VAC
- Voltage Output = 120 VAC
- Hertz = 60Hz
- Electrical Relay Operations = 100,000 Cycles
- RoHS compliant = Yes
- Storage Temperature = 32°F (0°C) to 135°F (57°C)
- Operating Temperature = 40°F (5°C) to 125°F (52°C)

Installation Examples:

Controlling a CO₂ Generator

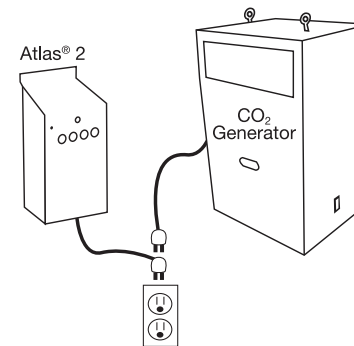

Controlling a CO₂ Tank with Regulator

